

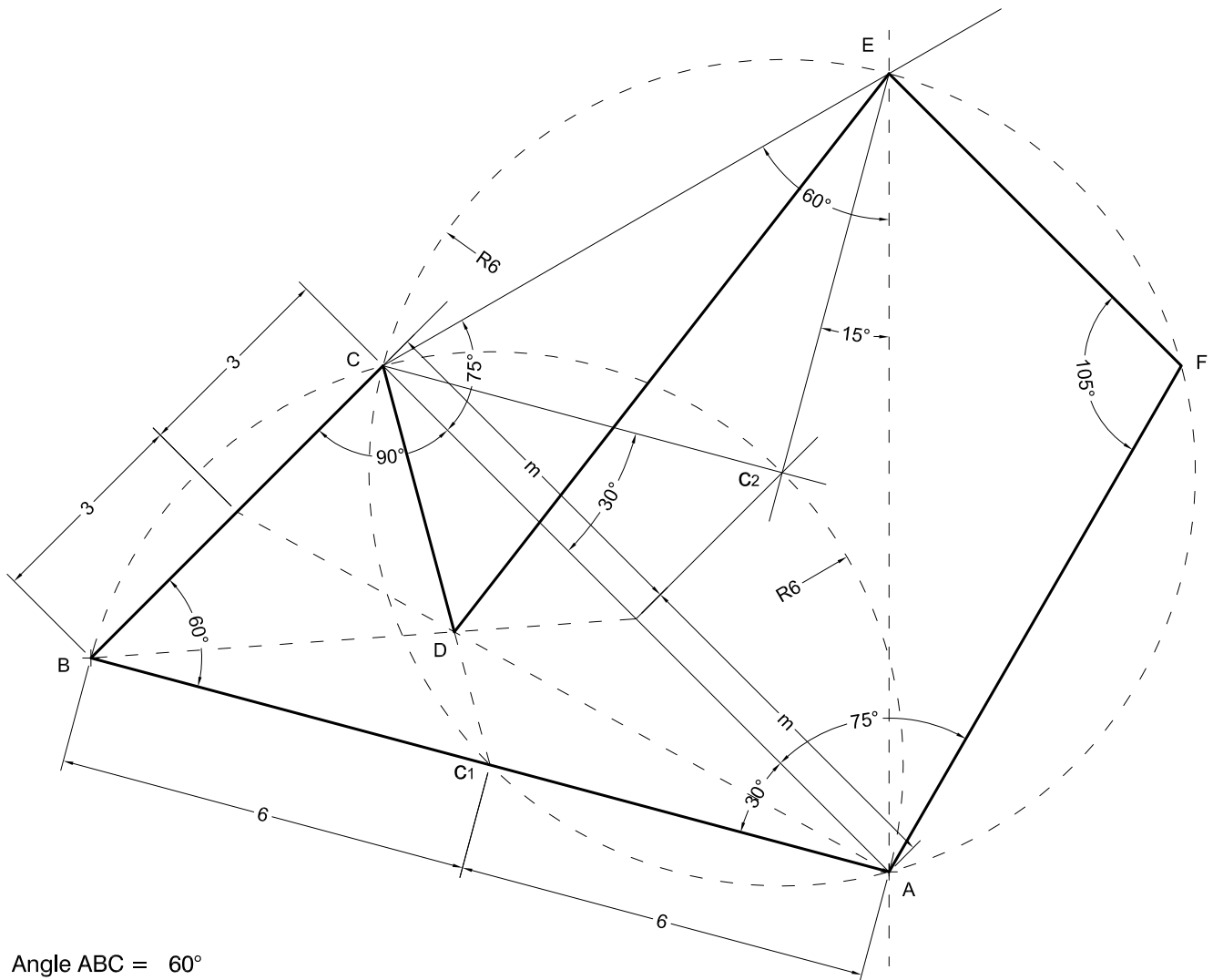

(1-1A)

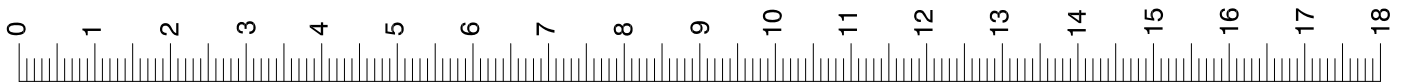

Angle ABC = 60°

Angle ACB = 90°

Vèrtex D = baricentre del triangle ABC

Angle ACE = 75°

Angle AEC = 60°

Angle CAF = 75°

Angle AFE = 105°



(1-1B)

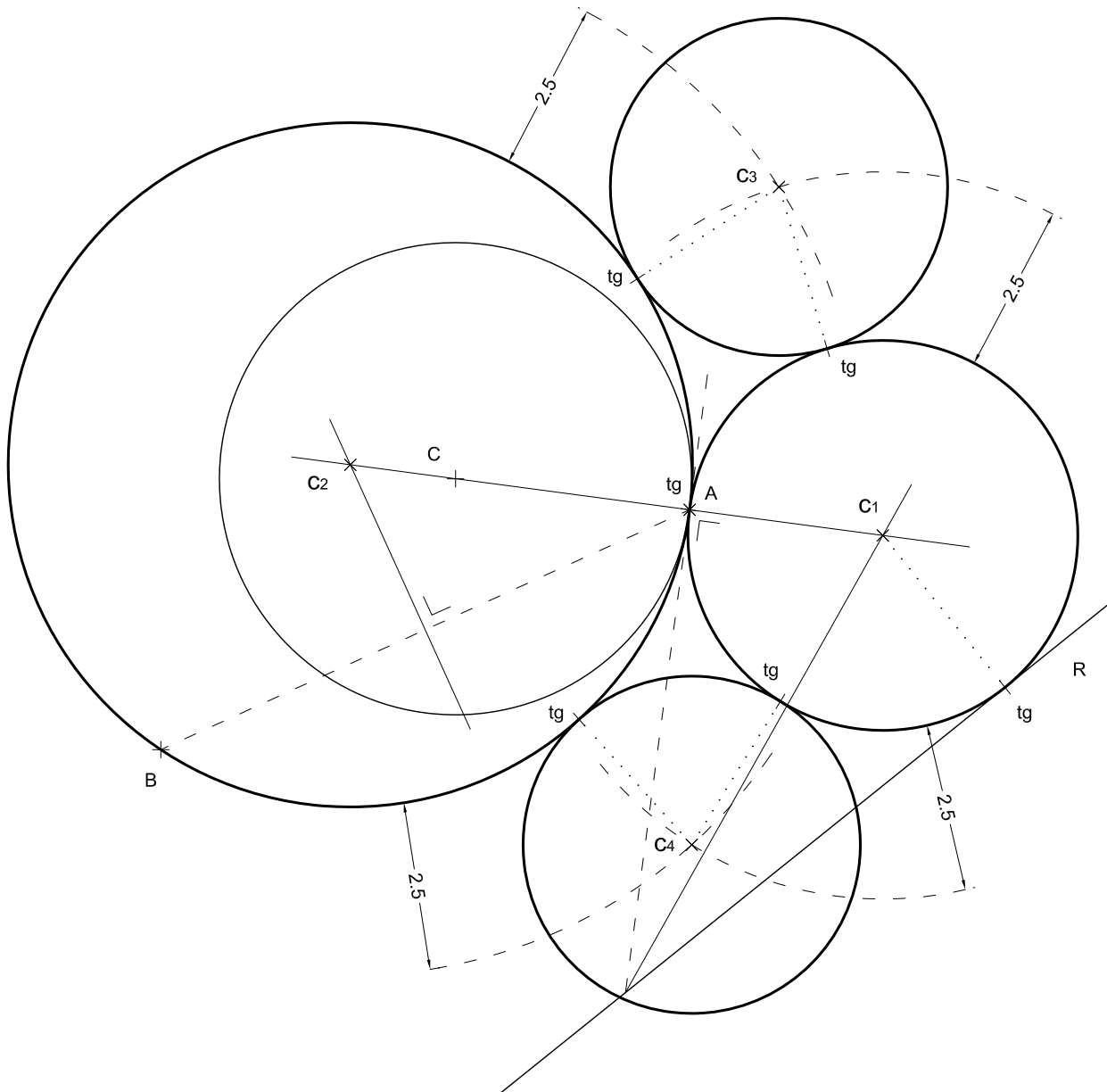
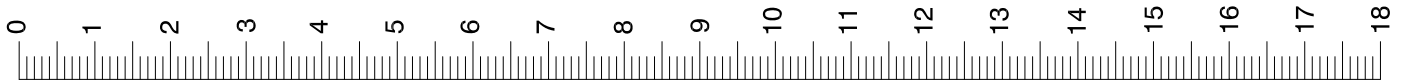



Criteris específics de correcció i qualificació per ser fets públics un cop finalitzades les proves
Dibuix tècnic

(1-2A)

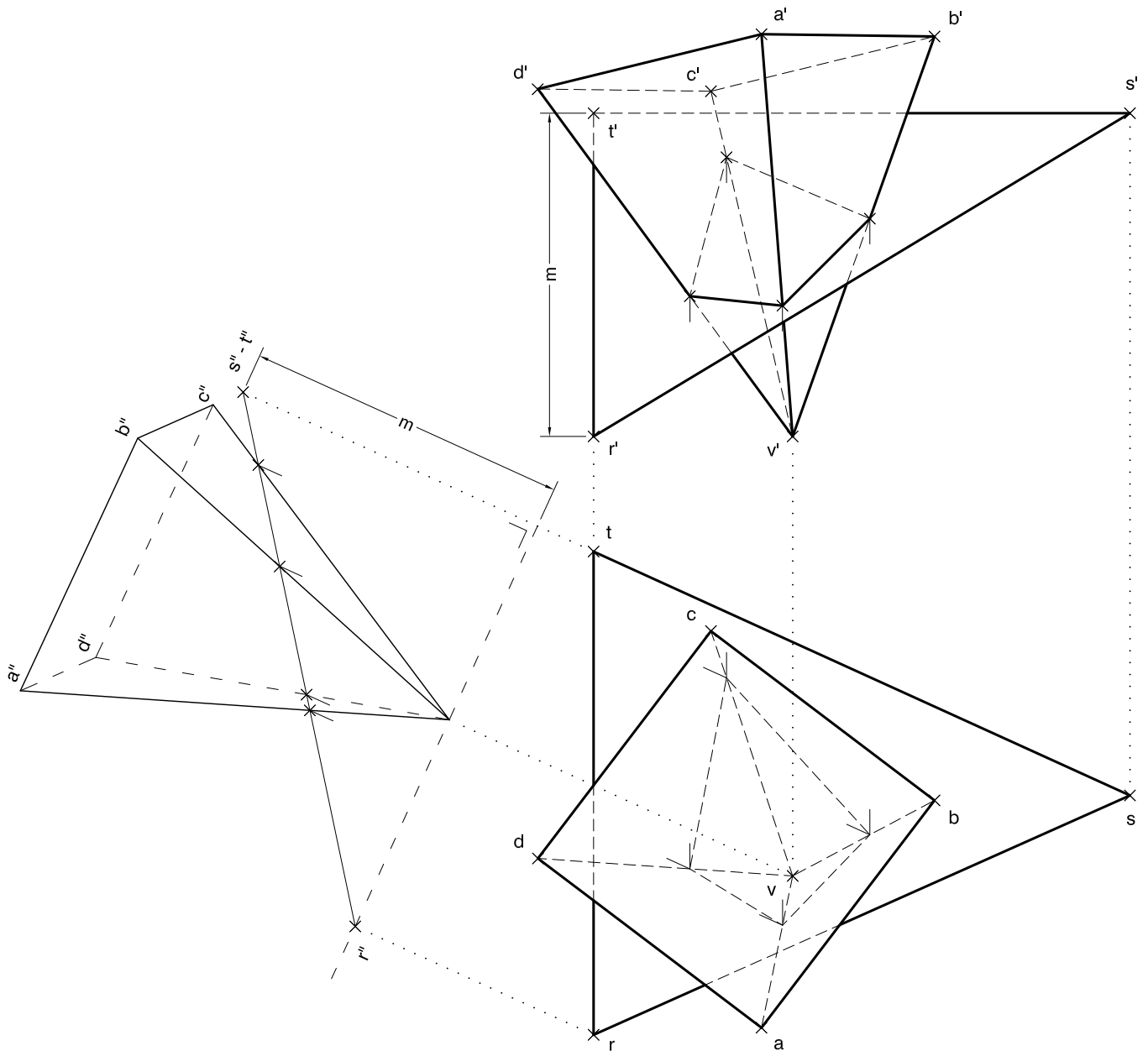
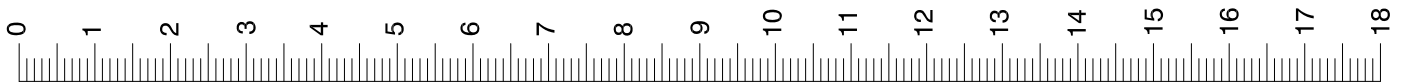



(1-2E)

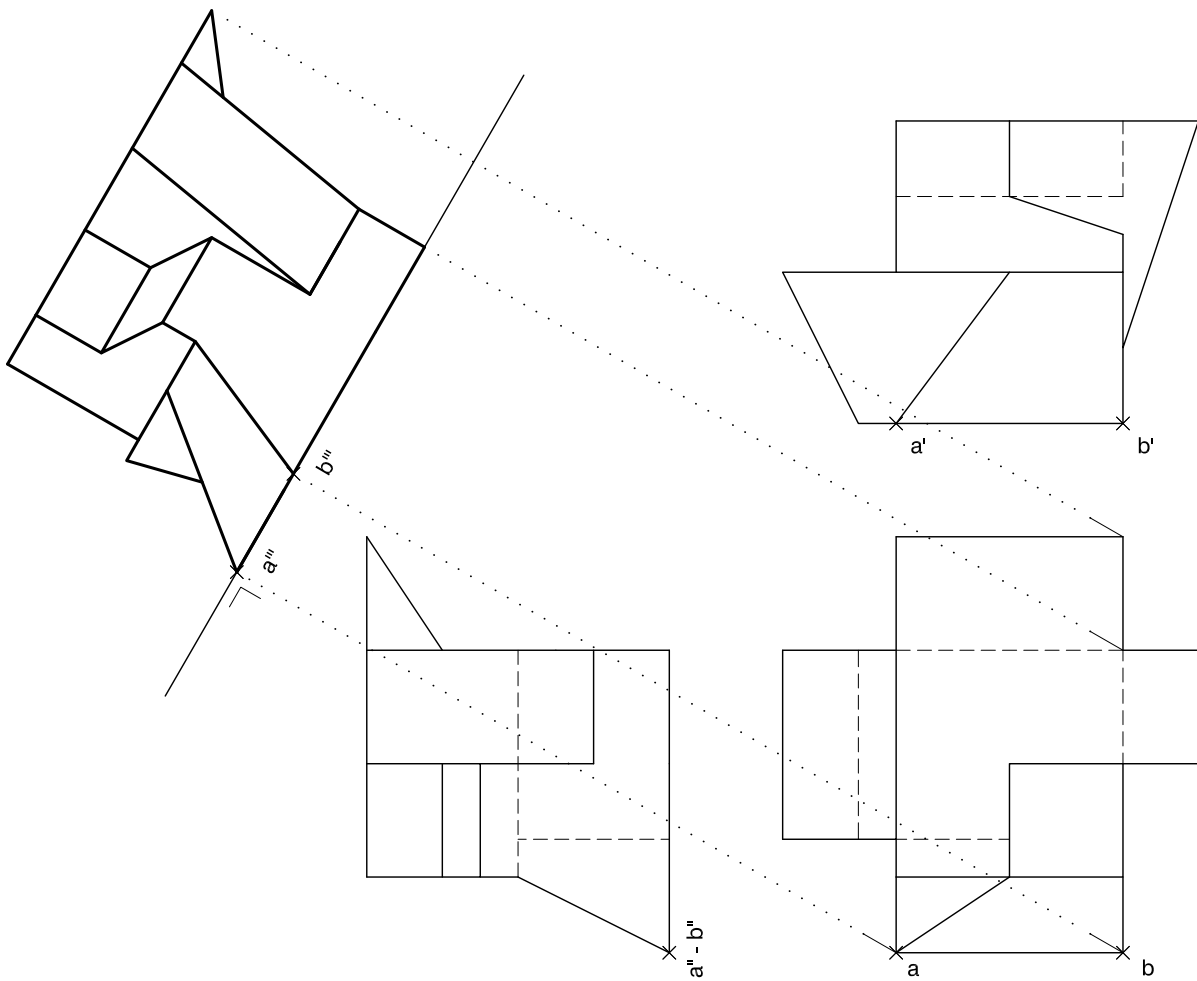
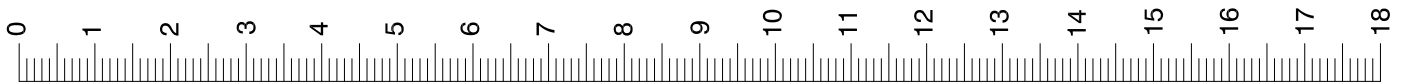



(t³A)

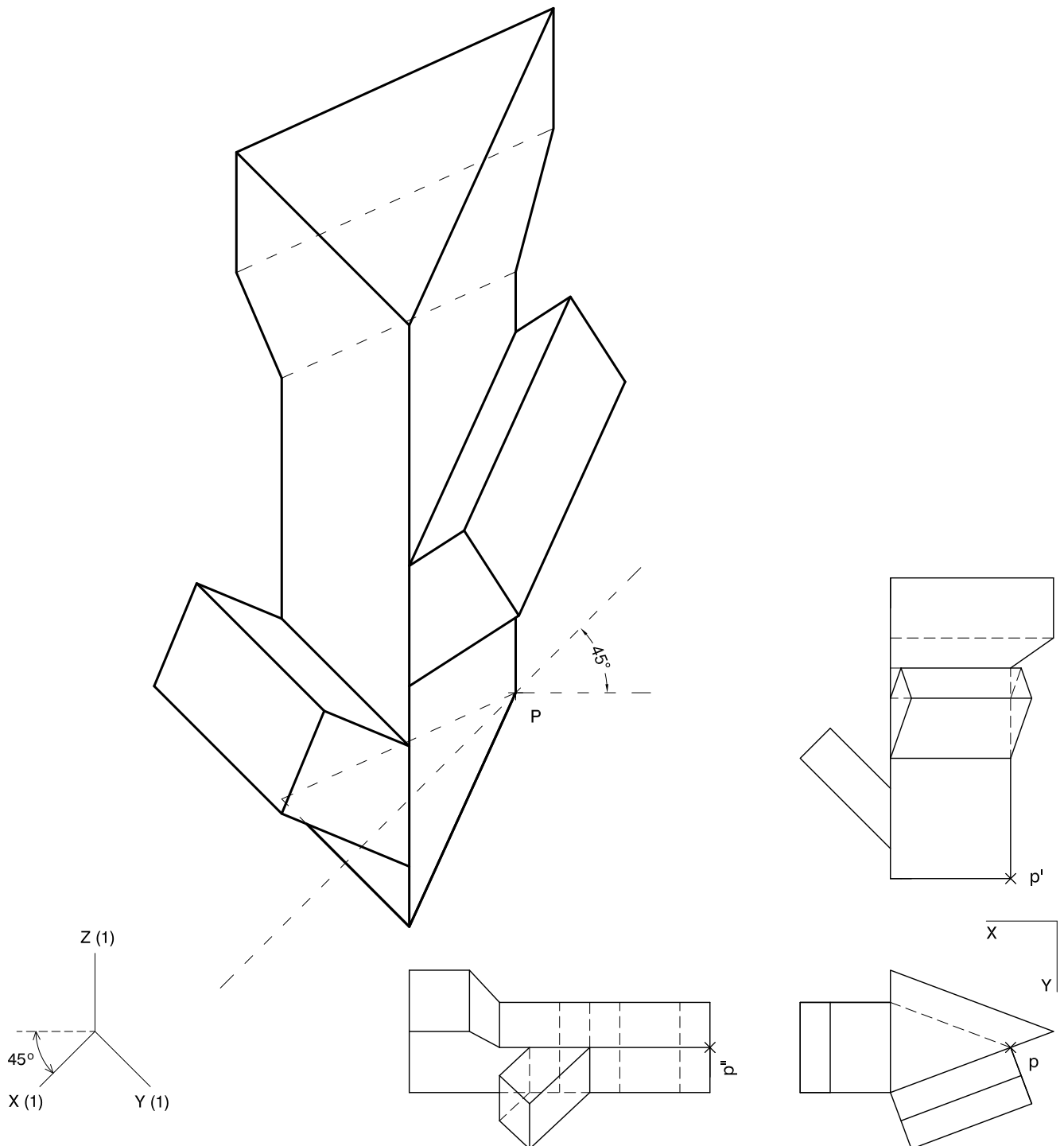
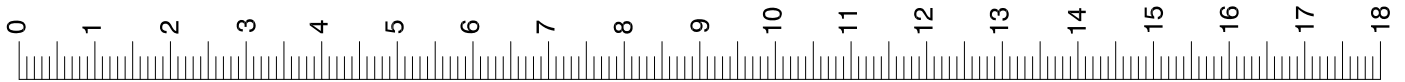



(1-3B)

